

FPC Operation Manual

1 Danger and warning

For staff and product safety please read the contents of this operating manual carefully before installation. The manufacturer shall not be held responsible for failure to comply with the instructions in this manual.

Check the following points as soon as you receive the FPC package:

- the packing is in good condition;
- the product has not been damaged during transit;

Disclaimer: actual product appearance may vary in accordance with latest design modification, that does not anyhow influence product performance.

Risk of electrocution, burns or explosion:

- the device must be installed and serviced only by qualified personnel;
- prior to any work on or in the device, switch off the power supply. The product needs to be mounted offline;
- always use an appropriate voltage detection device to confirm the absence of voltage;

2 Technical data

FPC is designed to receive signals from the FPAs, monitor the status of communication lines, register and display events. Main technical characteristic are provided below:

| Parameter | FPC 220S; FPC 220S (GSM) |
|--|---|
| Supply voltage | 100-240 V AC (50/60 Hz) |
| Power consumption, not more than | 60 W |
| Current consumption, not more than | 0.6 A |
| Maximum quantity of FPAs can be connected via Modbus | 32 (without using of a repeater) 99 (with using of a repeater) |
| Event log capacity | 20000 |
| RS-485 communication type | 9600/8-N-1 |
| Service interfaces | UART |
| Degree of protection | IP 30 |
| Mass, not more than | 500 g |
| Operating temperature | -10 °C ... +60 °C (indoor) |
| Housing material | ABS plastic |
| Service life, not less than | 10 years |

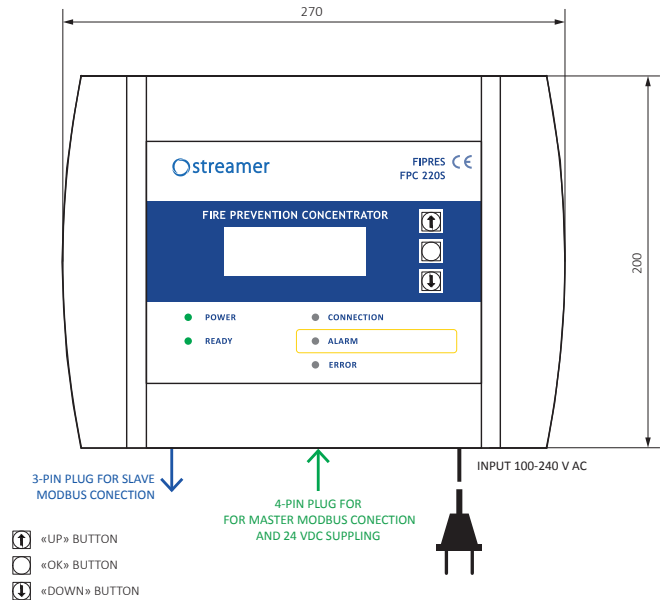

3 Mounting

It is recommended to install FPC in the room of the duty staff. FPC is mounted on the wall using screws, preliminarily removing the side covers. To remove the side covers it is required to pull the fixing elements out from the bottom side of FPC:

1. Remove the side covers

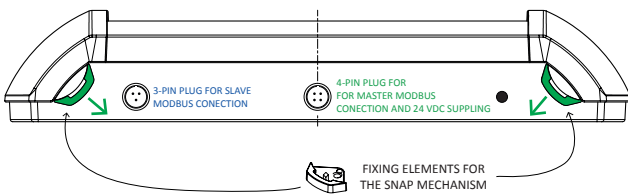

2. Mount on the wall using screws (not included in packaging)

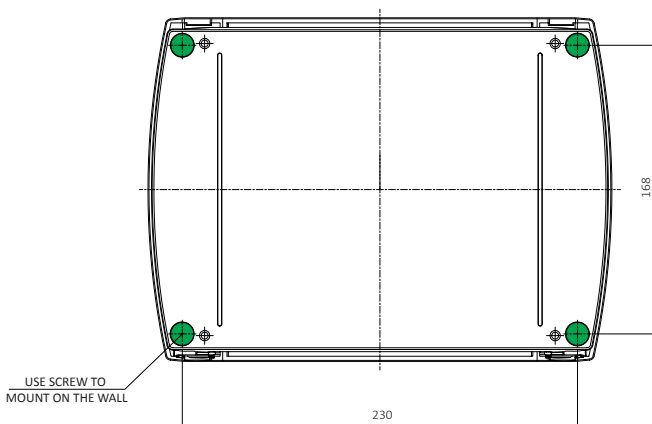

3. Install SIM-card (optional for FPC 220S (GSM) version)

To access the GSM module, you need to remove the left side cover. SIM card must be MINI-SIM size (25x15 mm) with ability of SMS sending

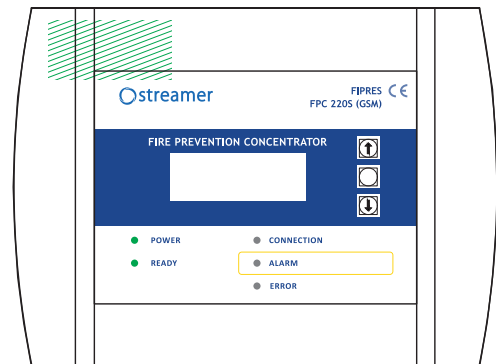

FPC Operation Manual

4 Connecting of FPC

Before connecting, we kindly ask to read Operation Manual for FPA

1. Connect all FPAs between each other and set the addresses

This process is described in details in FPA OM. It is recommended to set the addresses sequentially starting with 1 (e.g. 1,2,3 ...)

2. The wires outcoming from the last FPA should be plugged in a «female-type» cable connector

Cable connector is SF12 type and included in packaging. The scheme of connection is shown below. 24 V DC in this case is used for supplying of Modbus interface of FPC.

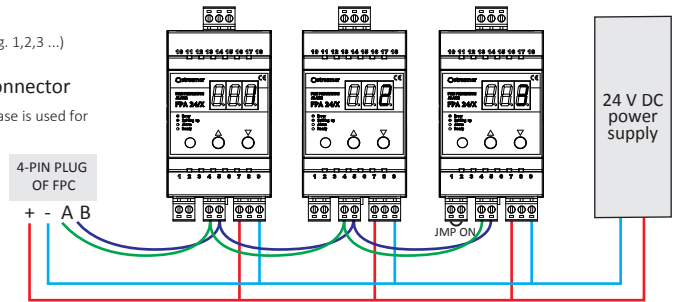
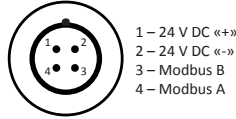

3. Plug cable connector from FPAs to FPC

4. If you want to transmit signal from FPC to external systems you need to connect FPC to Modbus external master device via similar cable connector:

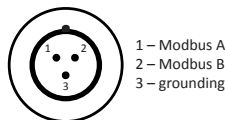

5. Connect dry contact output (optional)

Dry contact relay can transmit ALARM signal. To access the relay, you need to remove the left side cover. The scheme of connection is shown below. Contact 1-2 is normally open (NO); Contact 2-3 is normally closed (NC); The contact rating of the relay is given in Appendix B.

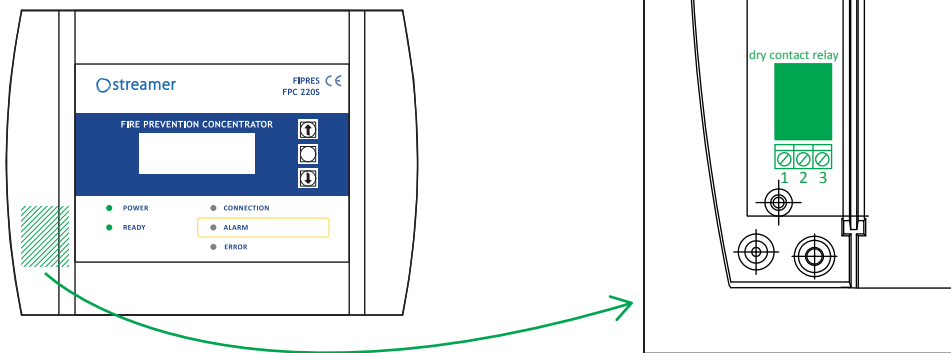

6. After mounting the FPC on the wall, putting a SIM-card, connecting all the FPAs, and connecting FPC to external system (if required) plug FPC into a power socket.

5 Setting up

Main screen of FPC is shown below:

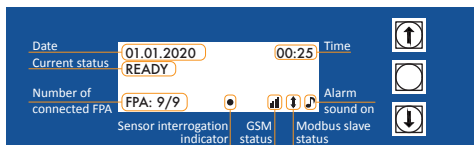

FPC is controlled via buttons. To go to the Menu press or button. To return to main screen wait for 10 seconds without pressing any buttons.

FPC Menu structure:

- | | |
|------------------------------|-----------------------|
| 1 Events log | |
| 2 Number of FPA | |
| 3 Data transfer | → 1 Modbus RTU ON/OFF |
| 4 Enable sound/Disable sound | 2 FPC Modbus addr. |
| 5 Set time | 3 GSM ON/OFF |
| 6 About | 4 Cellphone number |

Setting the number of connected FPA:

1. Menu → Settings → Number of FPA. Use or to increase/decrease the quantity of FPA, which will be interrogated by FPC.

If you have 4 FPA with addresses: 1, 2, 3 and 25 you need to set Number of FPA = 25. If you set Number of FPA = 4, only FPA with addresses less than 4 will be interrogated by FPC. That's why it is better to set addresses sequentially, starting with 1, i.e. 1, 2, 3, 4, 5 etc.

Setting data and time:

It is necessary to set time and date correctly to ensure proper displaying of SMS notifications and event log.

To set time and date go to: Menu → Settings → Set time

Real-time clock operation is provided by a pre-installed CR2032 battery. In case of resetting date and time after FPC restart, change the battery. Remove the right side cover for getting access to battery holder, that is located in right upper corner.

Enable/disable GSM module (for FPC 220S (GSM))

To enable of disable GSM module go to: Menu → Data transfer → GSM ON/OFF. GSM status will be seen on the screen in the right lower corner:



This icon does not indicate signal strength or SIM card availability. It only indicates that the GSM module is on and operational.

Setting phone number for SMS-notification receiving (For FPC 220S (GSM)):

Go to: Menu → Data transfer → Cellphone number

On the screen you will see the currently set phone number:

Press button to set new phone number. Wait for 8 second without pressing any button to exit.

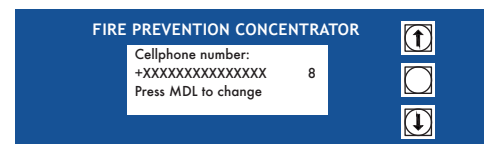

Set a new phone number digit by digit via pressing . Press to confirm the value and move on to the next one.



FPC Operation Manual

A quantity of digits depends on the country. Maximum length of number is 15 digits. If you entered the phone number and still have «X» skip them by pressing . After skipping all «X» new phone number will be set.

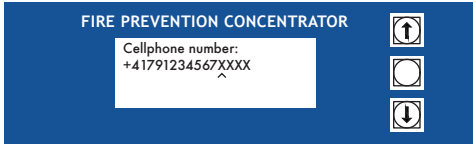

Enable/disable Slave Modbus RTU:

To enable of disable Slave Modbus RTU go to: Menu → Data transfer → Modbus RTU ON/OFF Slave Modbus RTU status will be seen on the screen in the right lower corner:

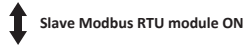

This icon does not show the connection status with any external system. It only indicates that FPC is available for interrogation via Slave Modbus connection.

Edit FPC Modbus RTU address:

To enable of disable Slave Modbus RTU go to: Menu → Data transfer → FPC Modbus addr. The default address of FPC is 13. If it's necessary use or to change FPC Slave Modbus address.

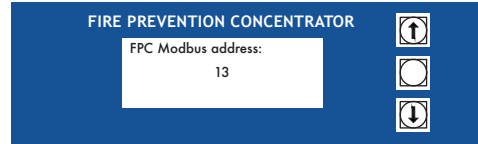

Information regarding the firmware version and serial number you can find there:
Menu → Settings → About

6 FPC operation

The normal mode of the system operation is the READY mode. In READY mode, FPC monitors the status of all connected FPA. Any other modes (FAULT or ALARM mode) require response by the duty or maintenance staff.

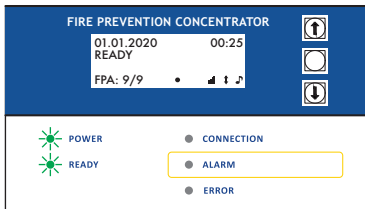

READY mode

If FPA detects a signal gas of rFPT or products of thermal insulation destruction in controlled volume, it switches to the ALARM mode and transmits alarm signal to the FPC. After that, the FPC switches to ALARM mode and provides an indication using audio signal, optical indicators and the display. In alarm mode, the FPC continues to monitor the status of the connected sensors. In the event of an alert from the another sensors, the FPC adds information about that on the display.

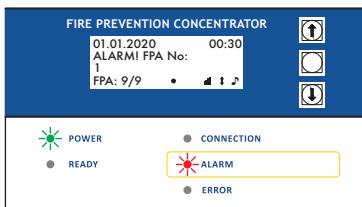

ALARM mode

In ALARM mode, the FPC displays the addresses of the triggered FPA. In addition, the FPC saves the event in non-volatile memory with a real-time mark. The alarm can be reset by pressing any key on the FPC built-in keyboard. After the ALARM resetting, the FPC display starts a countdown (30 seconds), during which the FPC will ignore the alert notifications from that FPA.

At the same time, the FPC 220 (GSM) sends an SMS message to the set number with the information about event (ALARM or ALARM resetting) and an address of FPA, which was triggered:

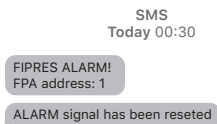

Don't forget to replace rFPT which was triggered with a new one!

Information about the date and time of triggering will be recorded in the event log, which can be accessed through : Menu → Events log. To navigate events log use or buttons.

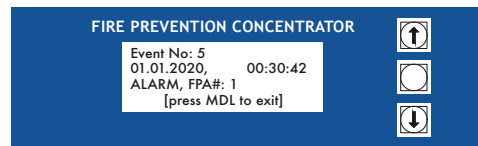

Events log screen

If FPA status will change from normal to malfunction, FPC switches to ERROR mode and provides an indication using optical indicators and the display. In ERROR mode, the FPC continues to monitor the status of the connected sensors.

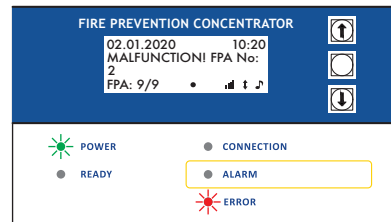

ERROR mode

In case of simultaneous ALARM and ERROR, the priority of the display will be given to the ALARM.

7 Appendix A. Modbus registers of FPC

The recommended algorithm for working with the control unit via RS-485 is continuous polling of register 0. If the value corresponding to ALARM or ERROR is read from register 0, it is necessary to start reading the registers 0..32 and / or 101 ... 132 in order to find out the addresses of triggered FPA. By default, FPC has address 13 on the RS-485 network. If necessary, it can be changed in the device menu

| Register no. | Register name | Value range |
|--------------|--|--|
| 100 | device type | 3 – FPC |
| 0 | general state of FPC | 13 – READY 18 – one or more FPA are in ALARM mode 23 – one or more FPA are in ERROR mode 33 – one or more FPA are in ERROR and ALARM mode |
| 1...99 | current state of each connected FPA (according to its adress in a range of 1...99) | 0 – FPA is not in ALARM mode (or not connected) 16 – FPA is in ALARM mode (for FPA 24/0.1/0.3/1) 1...15 – one or more corded sensor of FPA 24(4S) is in ALARM mode. <i>(each corded sensor is represented by certain bit in 1 byte number 0b0000ABCD).</i> A – corded sensor #1 (0 - READY; 1 - ALARM) B – corded sensor #2 (0 - READY; 1 - ALARM) C – corded sensor #3 (0 - READY; 1 - ALARM) D – corded sensor #4 (0 - READY; 1 - ALARM) Hence, for FPA 24(4S) the list of values is next: 1 (0b00000001) - corded sensor #4 is in ALARM mode 2 (0b00000010) - corded sensor #3 is in ALARM mode 3 (0b00000011) - corded sensors #3 and #4 are in ALARM mode 4 (0b00000100) - corded sensor #2 is in ALARM mode 5 (0b00000101) - corded sensors #2 and #4 are in ALARM mode 6 (0b00000110) - corded sensors #2 and #3 are in ALARM mode 7 (0b00000111) - corded sensors #2, #3, #4 are in ALARM mode 8 (0b00001000) - corded sensor #1 is in ALARM mode 9 (0b00001001) - corded sensors #1 and #4 are in ALARM mode 10 (0b00001010) - corded sensors #1 and #3 are in ALARM mode 11 (0b00001011) - corded sensors #1, #3, #4 are in ALARM mode 12 (0b00001100) - corded sensors #1 and #2 are in ALARM mode 13 (0b00001101) - corded sensors #1, #2, #4 are in ALARM mode 14 (0b00001110) - corded sensors #1, #2, #3 are in ALARM mode 15 (0b00001111) - corded sensors #1, #2, #3, #4 are in ALARM mode |
| 101...199 | current state of each connected FPA (according to its adress in a range of 1...99) | 0 – FPA is not in ERROR mode (or not connected) 16 – FPA is in ERROR mode (for FPA 24/0.1/0.3/1) 1...15 – one or more corded sensor of FPA 24(4S) is in ERROR mode. <i>(each corded sensor is represented by certain bit in 1 byte number 0b0000ABCD).</i> A – corded sensor #1 (0 - READY; 1 - ERROR) B – corded sensor #2 (0 - READY; 1 - ERROR) C – corded sensor #3 (0 - READY; 1 - ERROR) D – corded sensor #4 (0 - READY; 1 - ERROR) Hence, for FPA 24(4S) the list of values is next: 1 (0b00000001) - corded sensor #4 is in ERROR mode 2 (0b00000010) - corded sensor #3 is in ERROR mode 3 (0b00000011) - corded sensors #3 and #4 are in ERROR mode 4 (0b00000100) - corded sensor #2 is in ERROR mode 5 (0b00000101) - corded sensors #2 and #4 are in ERROR mode 6 (0b00000110) - corded sensors #2 and #3 are in ERROR mode 7 (0b00000111) - corded sensors #2, #3, #4 are in ERROR mode 8 (0b00001000) - corded sensor #1 is in ERROR mode 9 (0b00001001) - corded sensors #1 and #4 are in ERROR mode 10 (0b00001010) - corded sensors #1 and #3 are in ERROR mode 11 (0b00001011) - corded sensors #1, #3, #4 are in ERROR mode 12 (0b00001100) - corded sensors #1 and #2 are in ERROR mode 13 (0b00001101) - corded sensors #1, #2, #4 are in ERROR mode 14 (0b00001110) - corded sensors #1, #2, #3 are in ERROR mode 15 (0b00001111) - corded sensors #1, #2, #3, #4 are in ERROR mode |
| 7777 | network device address | 1...127 (13 - by default) |

8 Appendix B. Contact rating of dry contact output

| | | |
|-----------------------------------|------|----------|
| Contact capacity (resistive load) | 7 A | 220 V AC |
| | 10 A | 120 V AC |
| | 10 A | 24 V DC |

Contact us

Streamer Electric AG, HQ
Masanserstrasse 17
CH-7000
Chur, SWITZERLAND
Phone: +41 81 2500525
office@streamer-electric.com

Streamer Asia-Pacific
Asoke Towers - The Pride, room 203
219/2 Sukhumwit 21, Asoke
Klong Toel Nua, Wattana
10110 Bangkok, THAILAND
Phone: +66 (0)2 1209600

Streamer China
You Town Center Block A
Chaoyang Qu,
Beijing Shi, CHINA
Phone: +86 8565 1663

Streamer Indonesia
Wilson Walton Building
Jl. Raya Tanjung Barat 155 Jagakarsa,
Jakarta, INDONESIA
Phone: +62 21 7884 0737

