

1 Danger and warning

For personnel and product safety please read the contents of this operating manual carefully before installation. The manufacturer shall not be held responsible for failure to comply with the instructions in this manual.

Check the following points as soon as you receive the FPA package:

- the packing is in good condition;
- the product has not been damaged during transit;

Disclaimer: actual product appearance may vary in accordance with latest design modification, that does not anyhow influence product performance.

Risk of electrocution, burns or explosion:

- the device must be installed and serviced only by qualified personnel;
- prior to any work on or in the device, switch off the power supply. The product needs to be mounted offline;
- always use an appropriate voltage detection device to confirm the absence of voltage;

Risk of false triggering:

- It is necessary to turn off the system before paintwork

2 Technical data

FPA sensor is designed to detect the threshold concentration of the signal gas, as well as the products of thermal decomposition of the insulation in the volume of the protected object. The sensor is addressable.

Parameter	FPA 24(4S)
Supply voltage	12-28V DC (24 V DC is nominal)
Power consumption, not more than	7.5 W
EMC protection according to	EN 61000-6-5:2015 EN 61000-6-4:2007/A1:2011
Maximum number of corded sensors	4 (provided along with FPA 24(4S))
Maximum cable length of the corded sensors	10 meters
Type of sensitive element	metal-oxide semiconductor heated sensor
Protected volume, m ³	<4 m ³
Modbus interface characteristics	9600 bps, 8 data bits, 1 stop bit, none-parity
Interfaces	- RS-485 interface (Modbus RTU protocol) - dry contact output "ALARM" (normally open)
Mounting	DIN rail
Mass, not more than	400 g
Operating temperature	-10 °C ... +60 °C
Storage temperature	-15 °C ... +60 °C
Housing material	ABS plastic
Service life, not less than	10 years
Other features	reverse polarity protection; auto-calibration based on environment conditions

Notes:

FPA is not a measuring tool, it does not require metrological verification or calibration procedures
FPA is not intended for outdoor electric equipment or electrical panel with strong forced ventilation

The data exchange between the FPA sensors and the Fire Prevention Concentrator of the FIPRES system is carried out via the digital communication line.

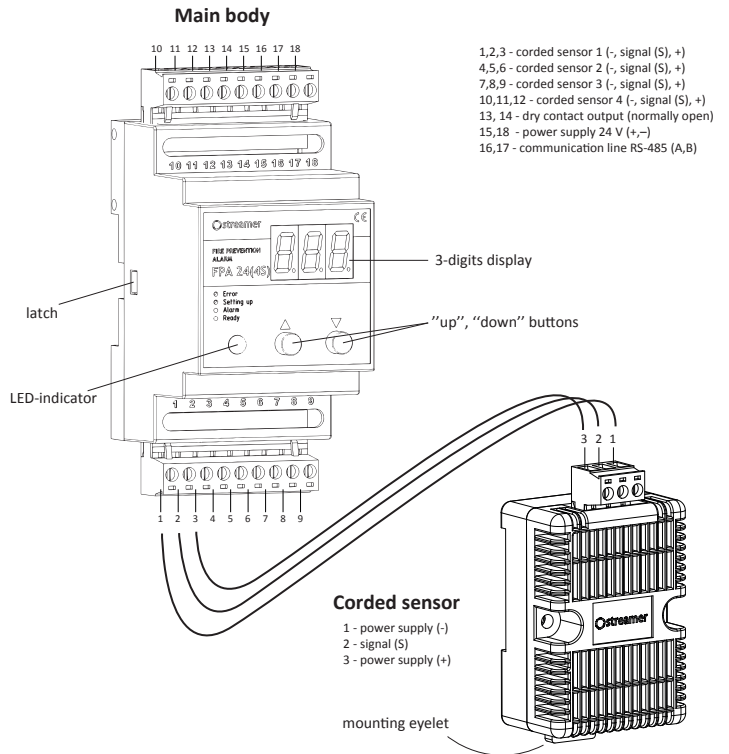

3 Installation

Corded sensors should be installed along with the rFPTs (in the same compartment) according to project documentation. Main body of FPA can be installed outside panel or in LV-compartment (for switchgears) so that the LED indicator can be observed by maintenance personnel.

The main body of FPA is mounted on **grounded** galvanized steel or aluminum DIN rail of TN35 type in accordance with IEC 60715. During the installation work, ensure that the mounted elements of the sensor do not damage vital elements. Corded sensors could be installed on DIN-rail (not necessary grounded) or using the plastic eyelet.

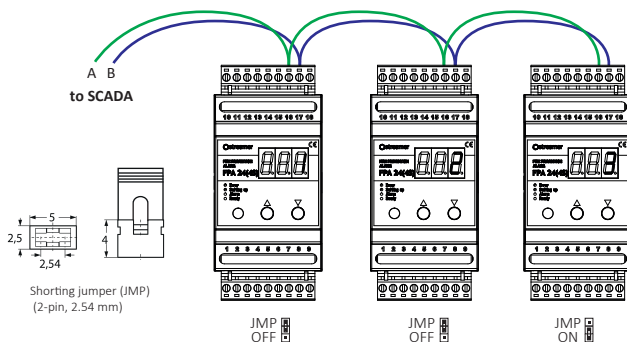

Shorting jumper (JMP) is supposed to be installed on the most distant FPA from Master device (SCADA or FPC) in case of using serial connection of few FPA (more than 3), or in case total length of connection cable exceed 100 meters.

To switch ON the jumper, remove FPA housing (using side latches), and change the position of the jumper as it is shown (default position of jumper is OFF)

For communication lines and power supply of FPA sensors it is allowed to use combined cable of U / UTP, FTP or STP type according to ISO / IEC 11801 or separate cables with copper conductors with a section of not less than 0.125 mm². When using multi-wire cables, cable lugs should be used. It is allowed to use cables with non-twisted conductors with a communication line length of only up to 50 m. The terminal block of power supply of FPA is designed for connecting conductors with a cross section of ≤1.5 mm².

When using a twisted pair cable, it is recommended to comply with the following scheme of the color coding:

- blue + white-blue - 24V power supply "-"
- orange + white-orange - 24V supply "+"
- green - RS-485 (A)
- white-green - RS-485 (B)

The FPA, which is the most distant from the control unit, should be equipped with a shorting jumper.

When arranging communication lines, it is not allowed to apply the star topology. On a practical level separate branches with a branch length of not more than 40 meters are allowed. Switching ON of shorting jumpers on such separate branches is not required.

In case of laying the communication line on objects with a heavy electromagnetic environment (>0.4 kV equipment), shielded twisted pair (STP) cable should be used. In this case the shield should be grounded at one point.

Use RS-485 repeater in case of the required length of the communication line exceeds 700 meters.

Shorting Jumper (JMP) position:

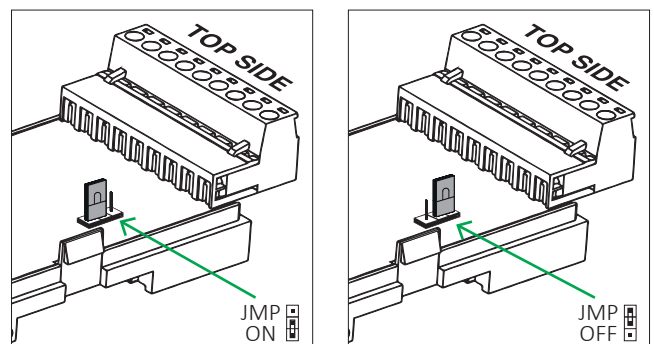

4 First start

1. Make sure that all corded sensors are connected to main body of FPA 24(4S)
2. Turn ON power supply of each FPA
3. After supplying, FPA goes to initial setup mode. It needs to adapt FPA to environment and to setup all connected corded sensors. In this mode the LED indicator of FPA flashes with green each 0.5 s. Procedure shall take up to 5 minutes.
4. After the initial setup, the FPA goes into READY mode, the LED indicator is solid green.
The buttons are inactive until the FPA enters READY MODE.
5. Set the Modbus address. All FPAs have address # 1 by default, but if you are using multiple FPAs connected to the same master (BMS, SCADA, FPC), you must configure all FPAs so that their addresses are unique. For convenience it is better to set addresses sequentially, starting with 1, i.e. 1, 2, 3, 4,...
- 5.1 To set up address, press and hold ▼ button for 4 seconds. FPA will go into setting up address mode. LED indicator starts glow with solid yellow, digits on a display start blinking.
- 5.2 Choose new address by pressing ▼ or ▲
- 5.3 After selecting, do not press any buttons for 5 seconds. FPA will set the new address

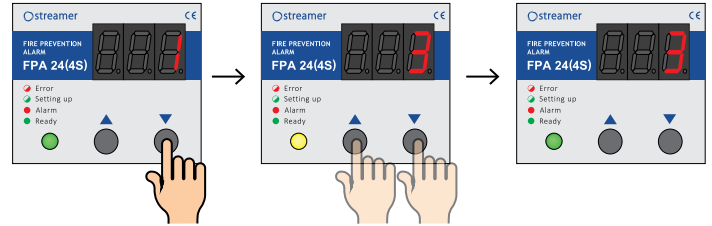

5 Choosing the mode of operation

There are 4 scenarios of FPA operation:

000 - Default mode. When FPA enters ALARM mode, it remains in ALARM mode until the signal gas concentration dropped back below the threshold value.

111 - ALARM sticking mode. When FPA enters ALARM mode, it remains in ALARM mode until one of the buttons is pressed, even if the signal gas concentration dropped back below the threshold value.

222 - Default mode with external corded sensor. In this mode corded sensor #4 should be placed outside panel to act as external sensor. External sensor scans environment outside the panel and adjusts the threshold of corded sensors #1, #2 and #3. This mode is intended for use on objects with a high concentration of intermittent foreign gases in the ambient air.

333 - ALARM sticking mode with external corded sensor. It is a combination of modes **111** and **222**

Default mode is 000, other modes should be considered only with specific purposes.

1. To select mode, press and hold ▼ and ▲ buttons simultaneously for 4 seconds. FPA will go into selection mode. LED indicator starts glow with solid yellow, digits on a display start blinking.
2. Choose mode by pressing ▼ or ▲
3. After selecting, do not press any buttons for 5 seconds. FPA will set the mode

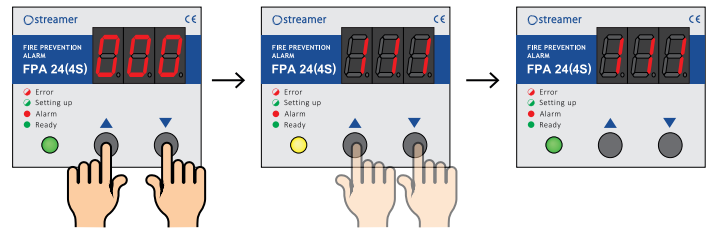

6 Choosing the volume of protected object

There is an option to set volume of protected object. Please note, that this volume will be set for all corded sensors, connected to main body of FPA 24(4S).

1. In case of installation the corded sensors in compartments with different volumes, the biggest volume must be chosen.
Example: Corded sensor #1,#2,#3 are installed in different compartments with 0.3 m³ of volume each, and corded sensor #4 is installed in a compartment with 1 m³ of volume. In this case the volume in FPA settings should be set = 1 m³.
 2. If several corded sensors in one large compartment with volume of more than 1m³, the volume in FPA settings should be set = 1 m³.
 3. In modes **222** and **333** the volume is being chosen only for corded sensors #1,#2 and #3
- Default volume of FPA 24(4S) is 1m³. Range of values: 0.1 - 1 m³ with a step of 0.1

1. To select volume, press and hold ▲ button for 4 seconds. FPA will go into volume selection mode. LED indicator starts glow with solid yellow, digits on a display start blinking.
2. Choose mode by pressing ▼ or ▲
3. After selecting, do not press any buttons for 5 seconds. FPA will set the volume.

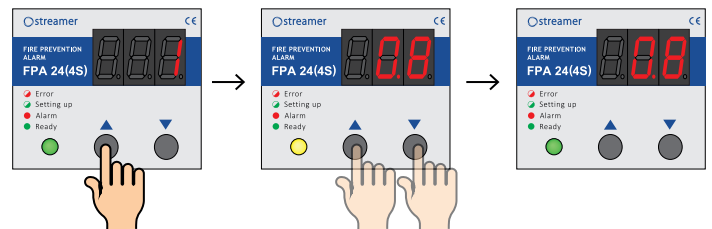

7 System operation

The normal mode of the system operation is the standby mode (READY). Any other modes (ERROR or ALARM) require intervention by the duty or maintenance personnel.

In READY mode, FPA checks the ambient air for the presence of rFPT signal gas. In case of signal gas detection FPA goes into ALARM mode, normally open dry contact output closes and FPA sends ALARM signal through Modbus line to Master device or FPC. FPA goes back into READY mode as soon as the concentration of signal gas drops back lower the threshold (in modes **000** and **222**) or as soon as the concentration of signal gas drops back lower the threshold + one of the buttons is pressed (in modes **111** and **333**).

FPA automatically calibrates itself during operation every few hours, depending on the environment. In modes **222** and **333** calibration is performed using an external sensor.

- READY:** The LED indicator is solid green
- ALARM:** LED indicator is solid red
- ERROR:** LED indicator flashes red
- SETTING UP:** LED indicator flashes green

If FPA is being polled by Modbus Master device (SCADA/BMS or FPC) the dots blink in turn:

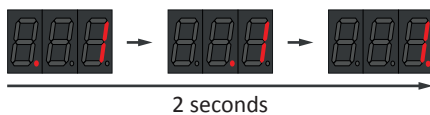

During the ALARM mode the display shows the corded sensors, which have been triggered. The points between digits glow are red. In case of 4 corded sensors are in ALARM mode, the display shows "A.L.L."

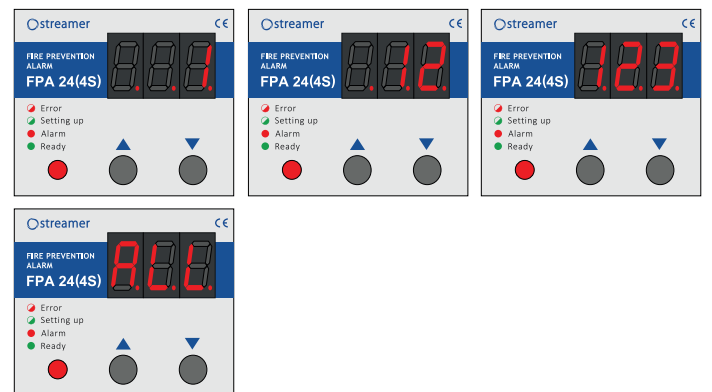

8 Possible faults and troubleshooting

The FPA sensors can generate false actuation alarms in some cases for the following reasons:

- high concentration of methane in a controlled volume (for example, in case of leaks from the fuel lines of gas piston generators or leaks from process lines);
- paint and varnish works using paint materials based on organic solvents;
- fire near the object of protection.

It is recommended to temporarily disable the system or individual sensors of the system during the production of large-scale repair and construction and painting works.

If the system does not operate correctly, the system should be restarted (by removing the supply voltage from the electronic components of the system), and then the following checks should be performed:

- check the value of the power supply voltage of the FPC and the FPA for compliance with the permissible ranges;
- check the temperature of sensitive elements of the FPA. To reach it, remove enclosure of corded sensor. In normal condition, they are heated to a temperature of about +60 °C (it is permissible to check by touching after switching off the power supply voltage of FPA)

9 Appendix A. List of Modbus registers

98	reading only	Sensor type	15 – FPA 24(4S)
99	reading only	Current state of FPA	13 – READY; 18 – ALARM; 23 – ERROR
100 - 103	reading only	Concentration of the signal gas (arb. units) from corded sensors 1, 2, 3, 4 respectively	0...1000
104	reading only	Threshold value of the concentration of the signal gas (arb. units) for ALARM	150 (for 1m³) - 250 (for 0.1 m³)
105 - 108	reading only	Current state of corded sensors 1, 2, 3, 4 respectively	13 – READY; 18 – ALARM; 23 – ERROR
109	reading only	Number of FPA operations (0 by default)	0...1000
110 - 113	reading only	Number of operations of corded sensor 1, 2, 3, 4 respectively	0...1000
114	reading + record	Mode of FPA operation	0 - default mode 1 - ALARM sticking 2 - default mode with external sensor 3 - ALARM sticking with external sensor
7777	reading + record	Current address of FPA	1...127

Appendix B. Contact rating of dry contact output

Contact rating (resistive load)	1A 24 V DC	Max. switching voltage	230 V DC 250 V AC
	0.5A 120 V AC	Max. switching current	2A
Min.load	0.01 mA 10 mV	Max. switching power	125 VA; 60 W

